

# LCD-SW900 INSTRUCTIONS

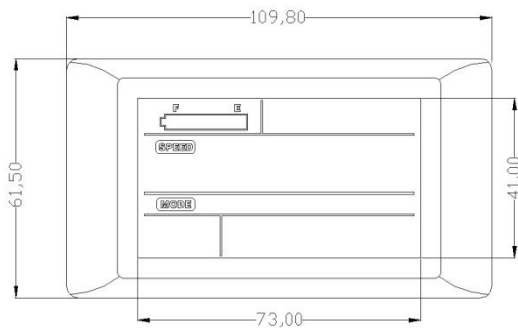

## 1. Shell's Size and Material

The shell's material is ABS. LCD screen is made of imported high hardness acrylic, and the hardness is equal to the tempered glass.



Front View

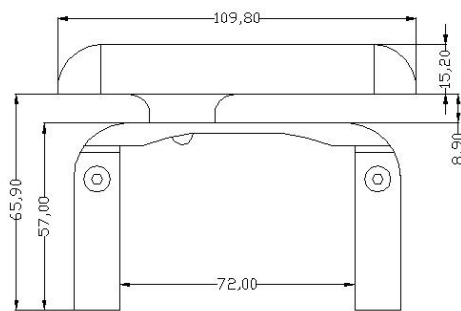

Side View

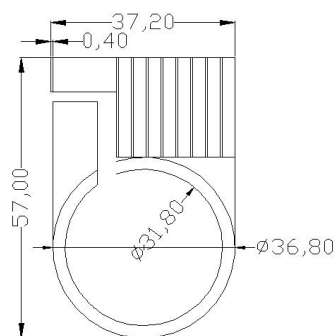

Side View of the Holder

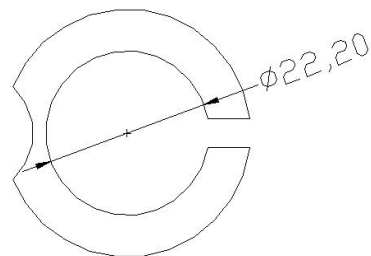

Optional size: 22.2mm, 25.4mm

## 2. Working Voltage and Mode of Connection

2.1 Working Voltage: DC24V 36V 48V (set by the meter), other voltage could be customized.

## 2.2 Mode of Connection:

Standard Connectors Line Sequence:

### 标配接插件线序



Red Line (D+): Power Positive

Black Line (GND): Power Negative

Blue Line (DS): Controller's electric door lock

Brown Line (DD+): Lighting control's Positive ( If the controller's software and hardware support the lighting control, do not need connect this line)

Green Line (RX): Receiving communication

Yellow Line (TX): Sending communication

White Line (GND): Lighting control's Negative

Extended Functions: PWM Assistance grades control, Independent external speed sensor

## 3. Functions

### 3.1 LCD Display

Speed indicator, PAS grades indicator, Battery indicator, Error indicator, Single Trip Distance and Total Distance, Headlight indicator.

### 3.2 Parameters Setting

Power on/off, Headlight on/off, 6KM/H Cruise control, Wheel size, Max speed setting, Auto stand-by and sleep mode setting, Background luminance setting, Working voltage setting.

### 3.3 Communication Protocol: UART

## 4. All contents on the screen

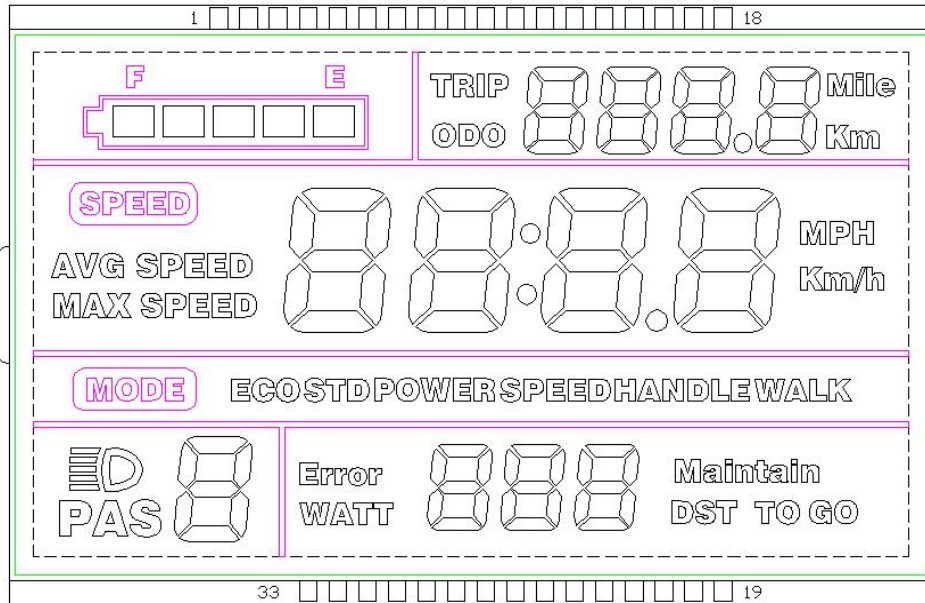

4.1 Headlight 

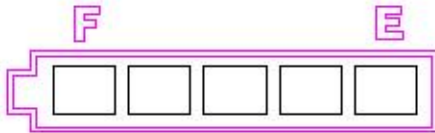
4.2 Power status 

4.3 Multi-functions **TRIP Error Maintain**  
**ODO WATT DST TO GO**

Total Distance(ODO), Single Trip Distance(TRIP), Error Code(Error), Wattage(WATT), Maintenance(Maintain), DST TO GO(Unused temporarily)

4.4 E-Bike Mode

**MODE** ECO STD POWER SPEEDHANDLE WALK

Economic mode(ECO), Standard mode(STD), Powerful model(POWER), Hand speed-control model(SPEEDHANDLE), Walk assisted model(WALK)

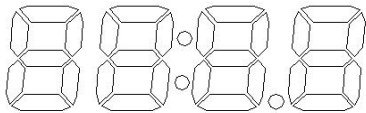
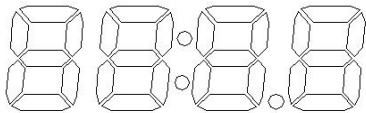
4.5 Speed display **SPEED**  
AVG SPEED  MPH  
MAX SPEED  Km/h

Maximum speed(MAX), Average speed(AVG)

MPH, KM/H are both optional.

According Wheel size and signal data, the meter could figure out the real speed.

4.6 Error display **Error** 

Meaning of Error Code:

Error Code	Error Status	Notes
------------	--------------	-------

0	Normal Status	
1	Save	
2	Brakes	
3	PAS problem(a riding mark)	not implemented
4	6KM/H cruising	
5	Real-time cruising	
6	Battery is under-voltage	
7	Motor's problem	
8	Throttle's problem	
9	Controller's problem	
10	Communication Receiving problem	
11	Communication Sending problem	
12	BMS Communication problem	
13	Headlight problem	



#### 4.7 PAS grades

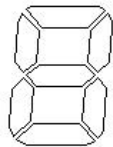

PAS Status (0-9 grades), Cruise mark



#### 4.8 Parameters setting

P01 Background luminance. 1 is the darkest, 3 is the brightest

P02 Unit of the mileage. 0 is KM, 1 is MILE

P03 Voltage grades. 24V, 36V, 48V. The original voltage is 36V.

P04 Sleep time. 0 is without sleep, other numbers stand for the sleep time (1-60 min).

P05 PAS grades.

0, 3 grades mode: 1 grade 2V, 2 grade 3V, 3 grade 4V

1, 5 grades mode: 1 grade 2V, 2 grade 2.5V, 3 grade 3V, 4 grade 3.5V, 5 grade 4V

P06 Wheel size. Unit: inch. Precision: 0.1

P07 Speed measuring magnet. Range: 1-100

P08 Speed limit. Range: 0-50km/h, 50 means without limit

No-Communication Status (controlled by the meter): when the real speed is over the ones we set, the meter would shut off PWM output; when less than the speed we set, the meter would turn on PWM output automatically, the driving speed would be  $\pm 1$ km/h; (Speed limit is for PAS, not for Throttle)

Communication Status (controlled by the controller): The driving speed keeps same with the ones we set. Random error:  $\pm 1$ km/h. (Speed limit is for both PAS and Throttle)

Notes: These data are based on KM. When changing KM to Mile, the speed value on the screen would convert to correct Miles automatically, but if you do not change the setting of speed limit from KM to Mile, it would be different from the real speed limit in Mile.

- P09 Zero start & Non-zero Start. 0 is Zero Start, 1 is Non-zero Start
- P10 Driving mode.
  - 0 is driven by PAS. Throttle is useless at this time.
  - 1 is driven by Throttle. PAS is useless at this time.
  - 2 is driven by PAS & Throttle. Throttle is useless at Zero Start status.
- P11 PAS sensitivity. Range: 1-24
- P12 PAS start strength. Range: 0-5
- P13 PAS magnet type. There are 3 types: 5, 8, and 12.
- P14 The Current-limiting of Controller. The original Current is 12A. Range:1-20A
- P15 Not implemented now.



P16 Reset ODO. Long press  for 5s, ODO could be reset.

## 5. Button Introductions



5.1 During riding, need change PAS/Speed grades, shortly press



5.2 During riding, need change data in Multi-function Area, shortly press



Long press , could switch status between MODE and ON/OFF;

Long press as a compound button, is mainly used for parameter setting, which could reduce misoperation due to complicated operation.

(No compound button with short-time press, because it's difficult to operate.)

### 5.3 Specific operation explanations

#### 5.3.1 Change PAS grade

Suppose it's PAS mode now,



shortly press , PAS grade +1



shortly press , PAS grade -1

### 5.3.2 Shift the speed display

Long press  + , to shift the way of speed display

### 5.3.3 ON/OFF 6KM/H cruising, ON/OFF Headlight, Reset ODO

When e-bike stops, long press  to enter 6KM/H cruising mode. Stop pressing to exit the cruise mode;

Long press  to turn ON/OFF Headlight;

At P16, long press  for 5s to reset ODO.



### 5.3.4 ON/OFF the screen

Long press  to turn ON/OFF the screen.

### 5.3.5 Change data in multi-function Area

Shortly press  to change data.



### 5.3.6 Parameters setting

Long press  +  to start setting parameters, such as wheel size(inch), background luminance... (Refer to P01-P16)

On the setting interface, shortly press , or  to plus/minus value. Parameters would be shining after modifying, choose the ones you prefer,

a. Long press  to save the value, the shining would stop.

b. Shortly press  to shift to the next parameter, and to save current values at the same time.

c. Press  +  to exit setting parameters and to save values. If not press these buttons, it would exit and save parameters modified automatically 10s later.